

LOCKERS laminate finish

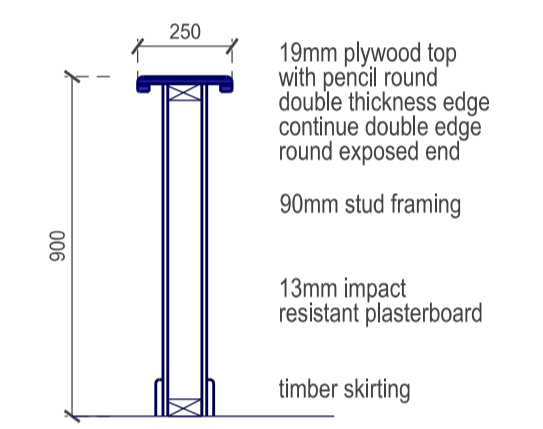

PLAYROOM 1 LOW WALL 1:20

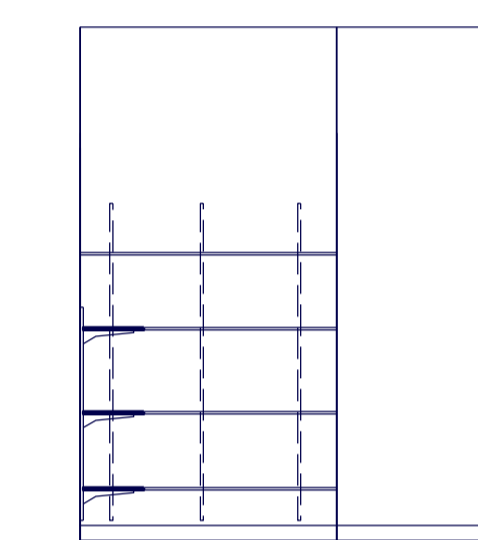
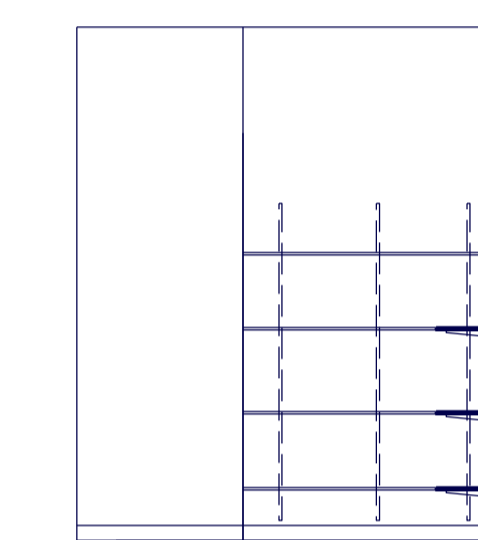
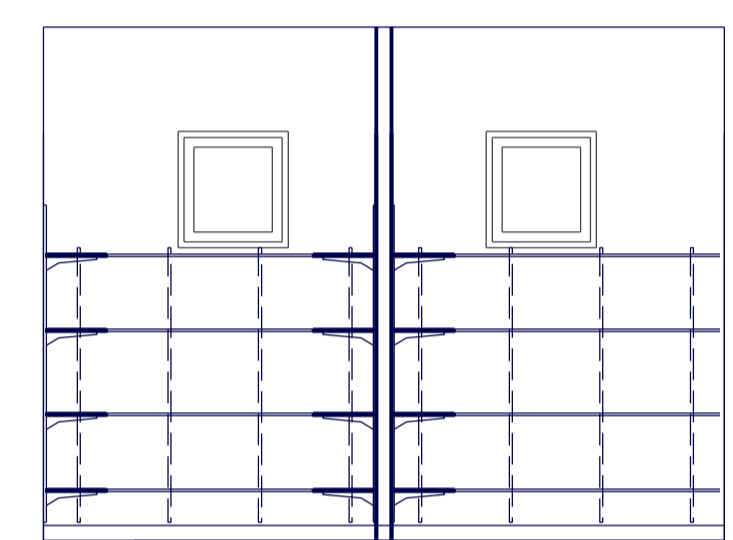
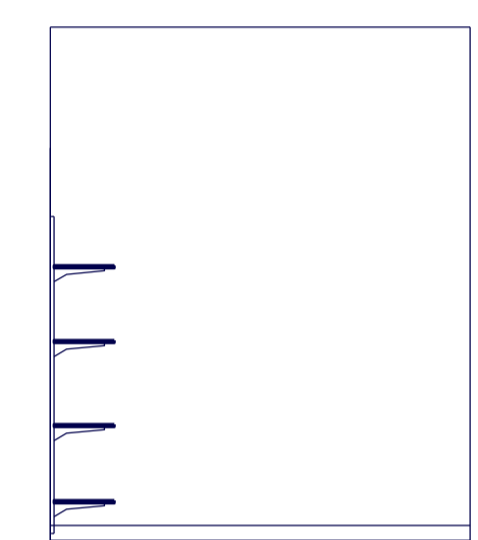
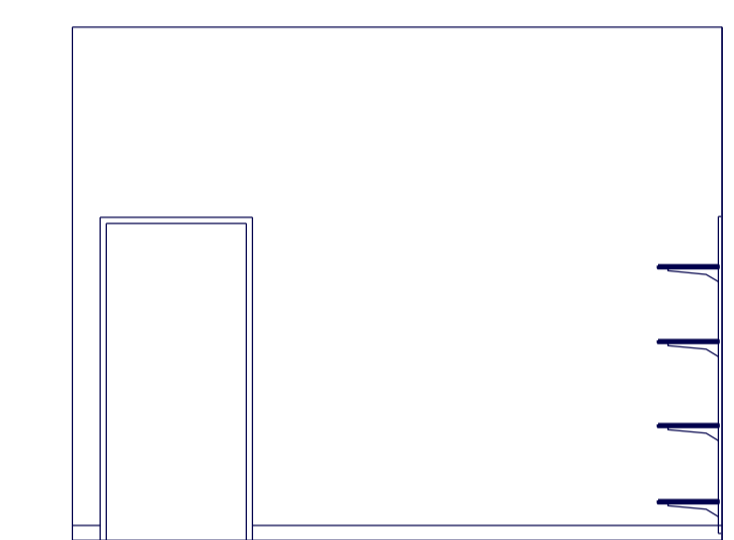
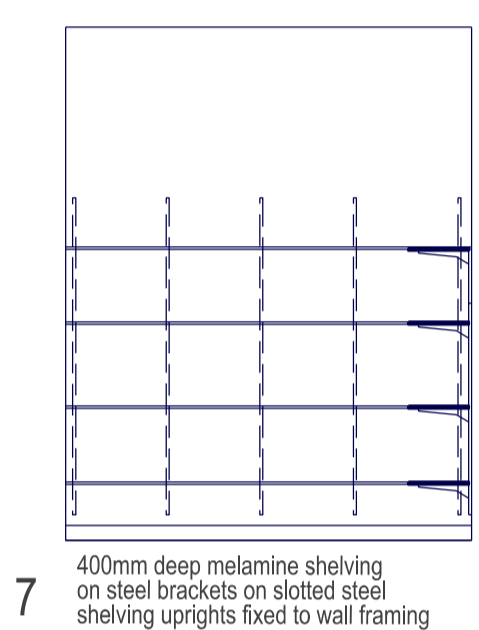
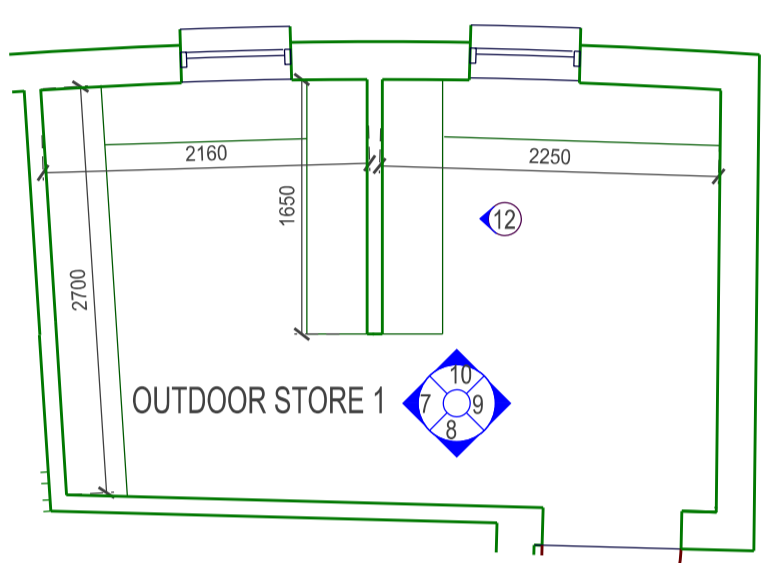
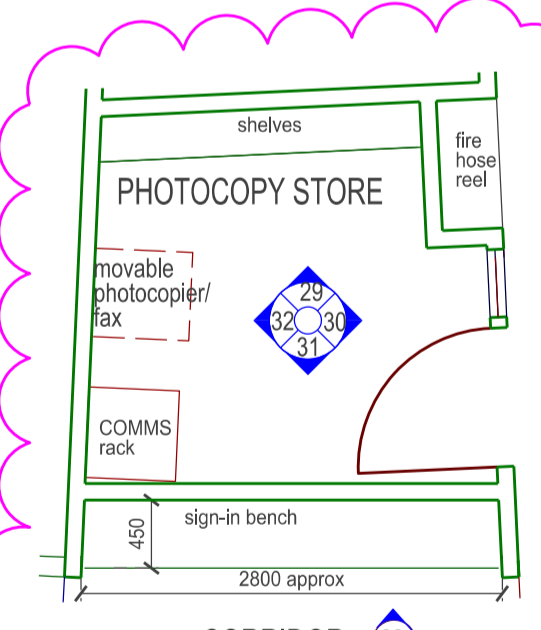
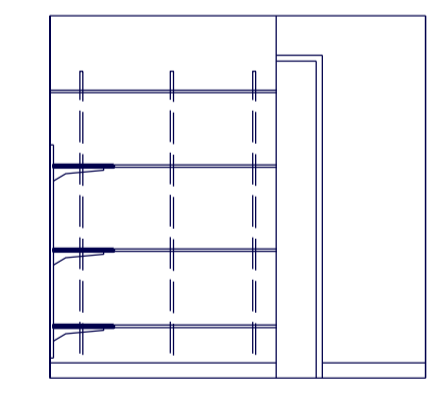
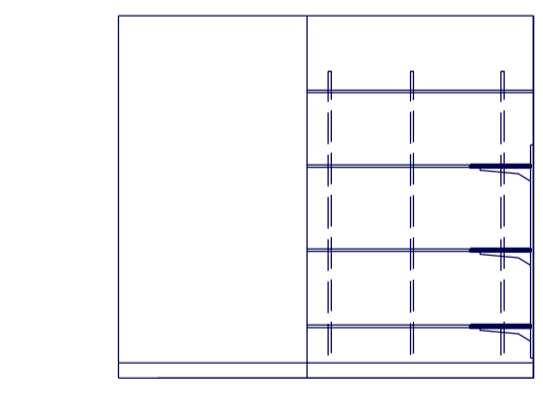
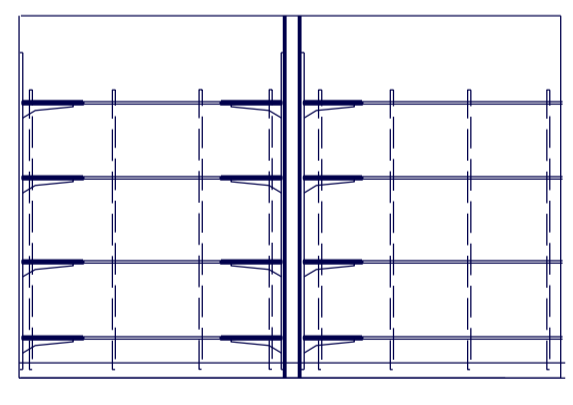
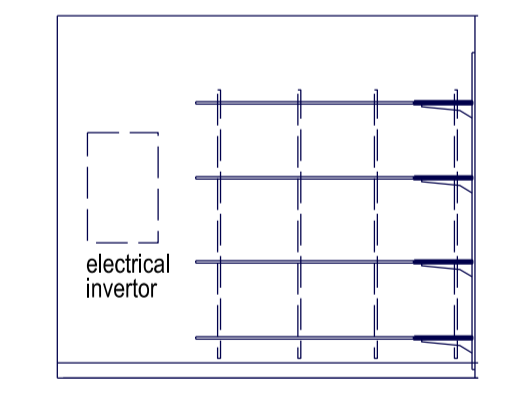
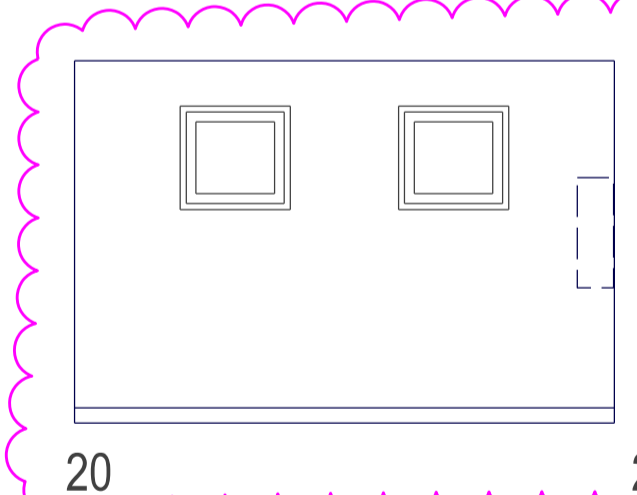
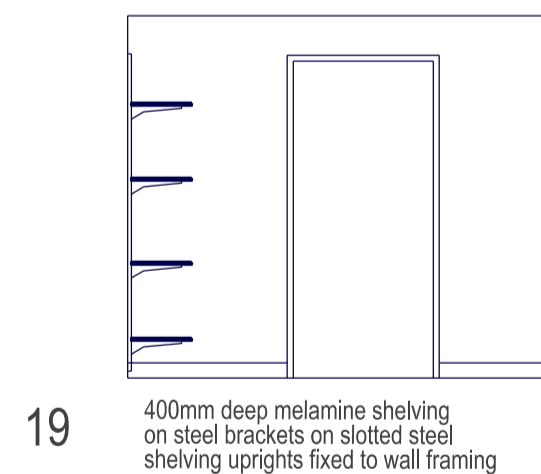
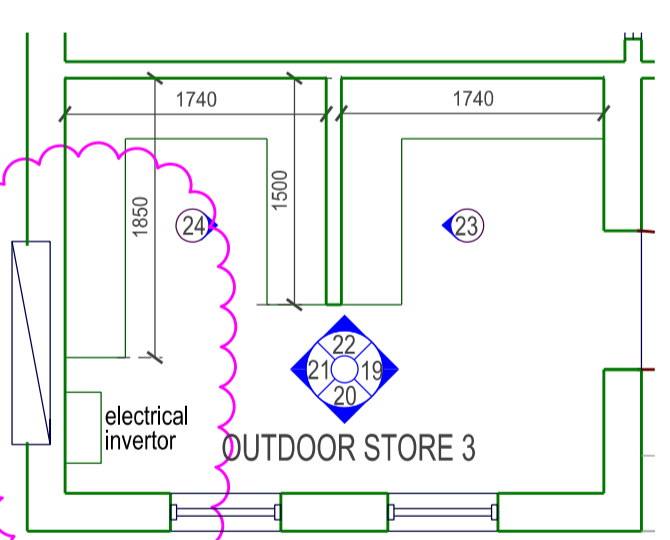
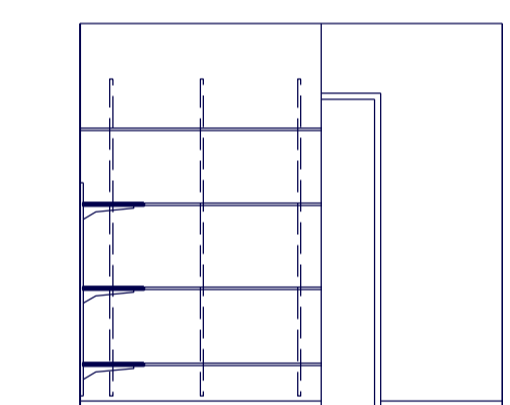
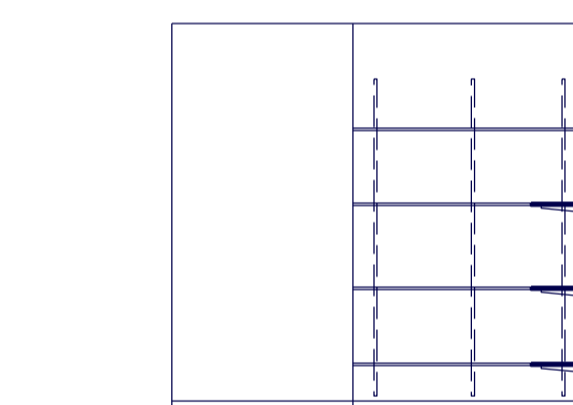
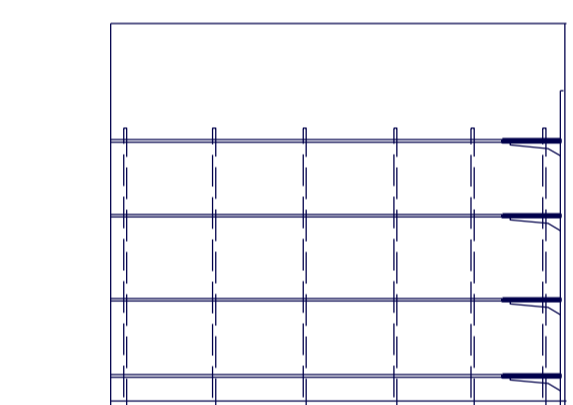
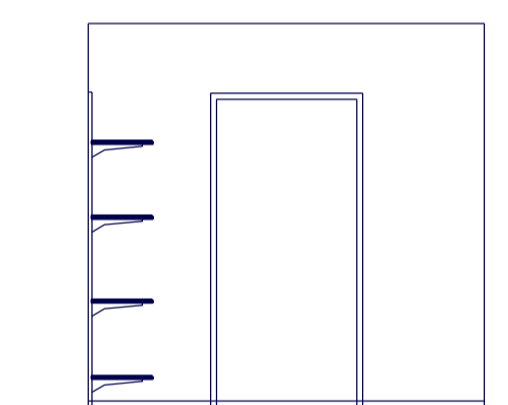
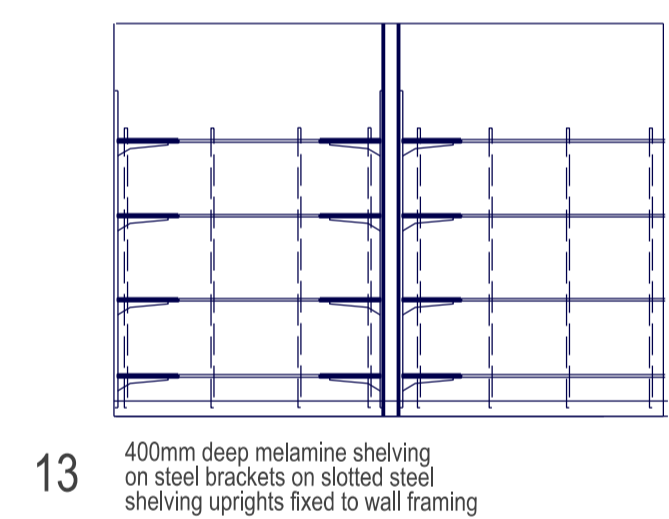
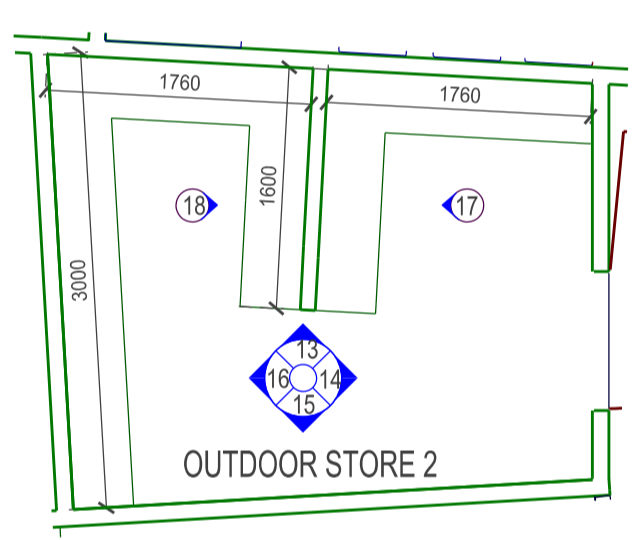

CORRIDOR

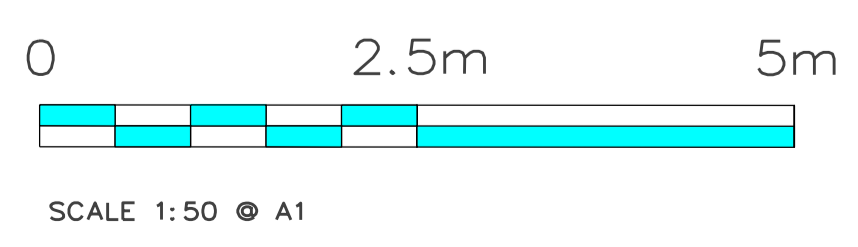
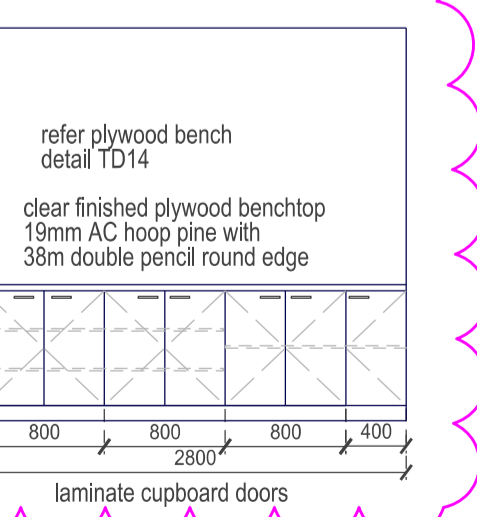
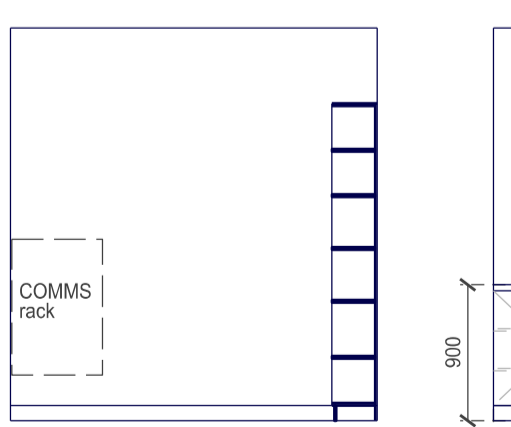
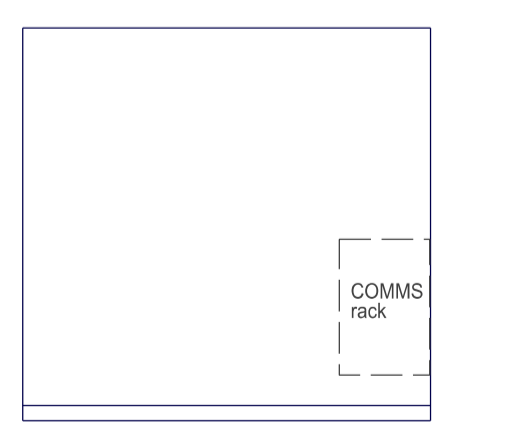
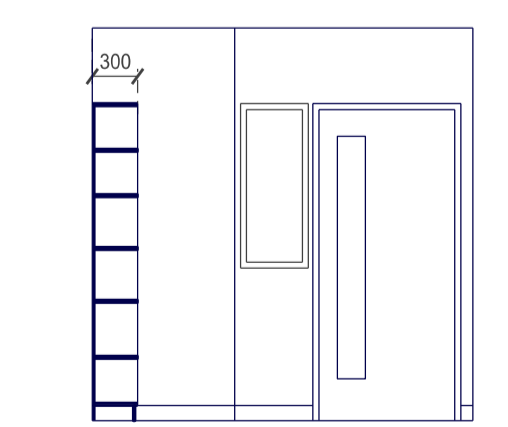
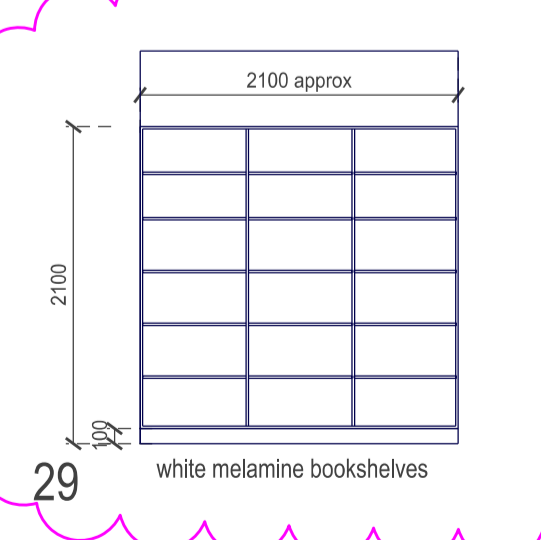
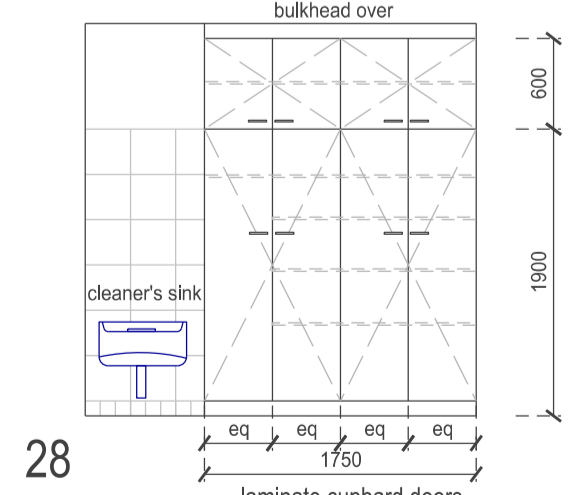
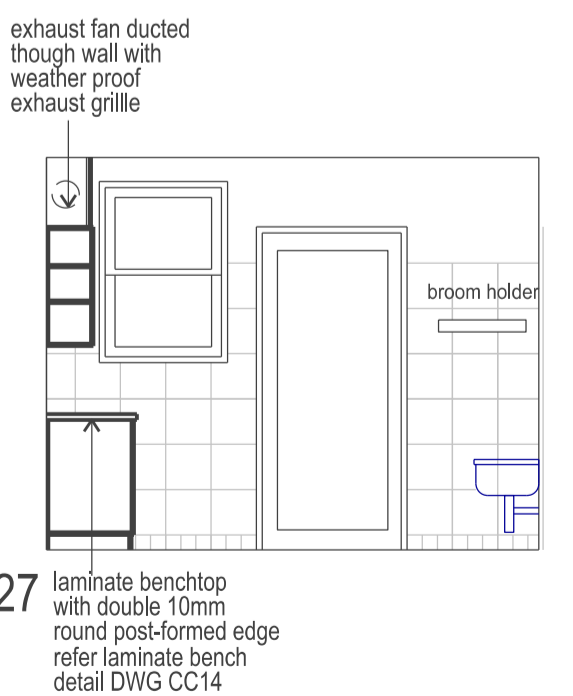
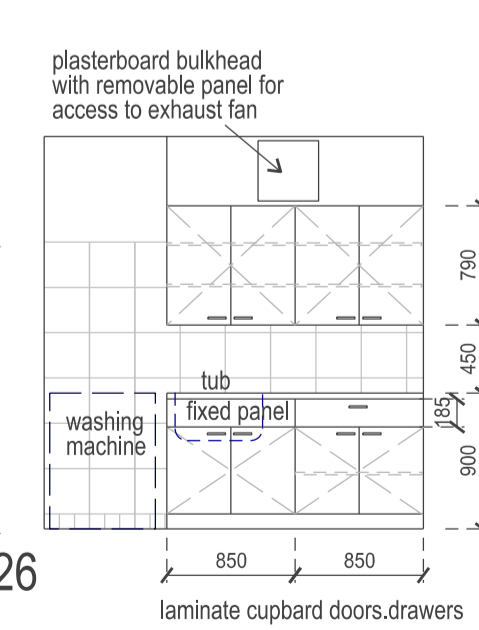
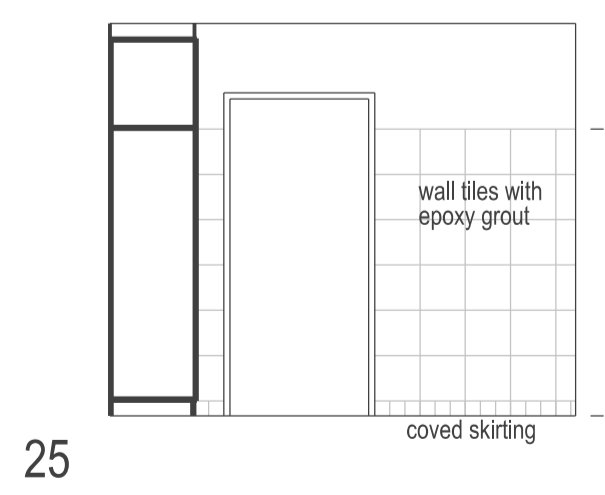
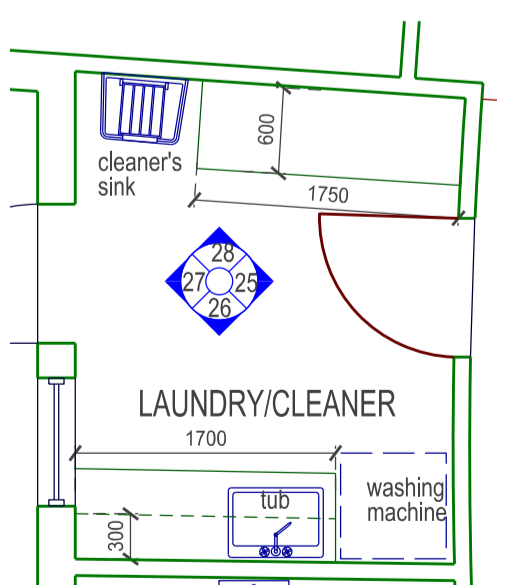

**Dillon & Savage Architects**  
 40 Quinton Rd, Manly, 2095  
 Phone: (02) 9977 3714 Fax: (02) 9977 8215  
 email: dsarchs@bigpond.net.au

Client  
**LEICHHARDT COUNCIL**

Project  
 Proposed Child Care Centre  
 Leichhardt Park

Drawing  
**ROOM ELEVATIONS SHEET 3**

Date	Amendment
C	16/7/15
B	19/4/15
A	23/3/15

Drawing No. <b>103 131 TD13</b>	
Issue <b>C</b>	Date <b>March 2015</b>
Scale <b>1:50 @A1</b>	Drawn <b>Checked</b>